

INSULATING BUSHES

24-3-14 GF

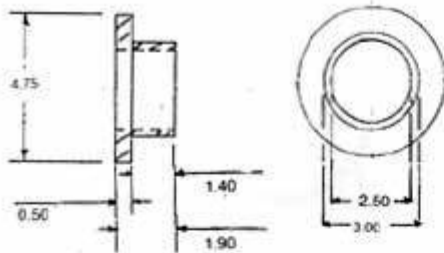

25-34-25 GF

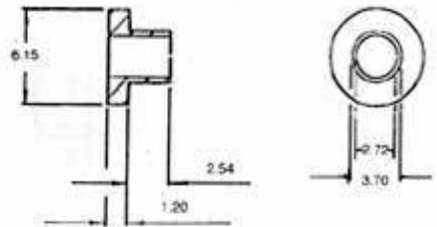

29-36-20 GF

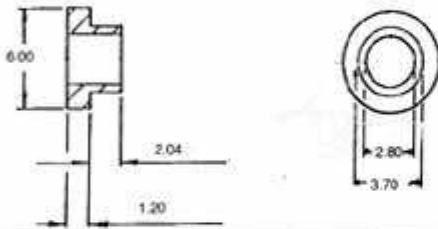

29-36-25 GF PPS No Longer Available

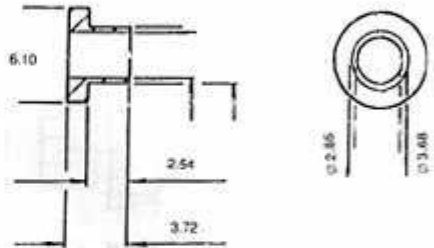

3-37-11 GF.PPS

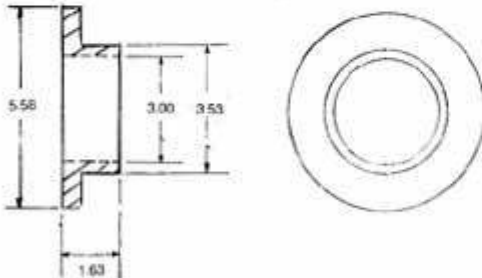

3-39-15 GF No Longer Available - ask for alternatives

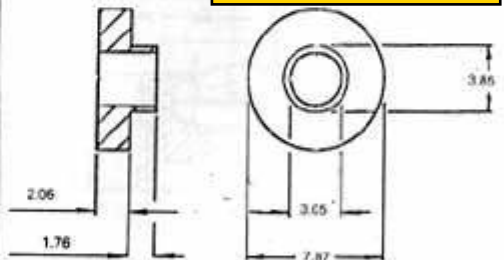

3-47-1 GF

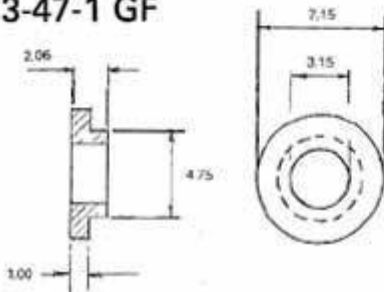

31-37-11 GF

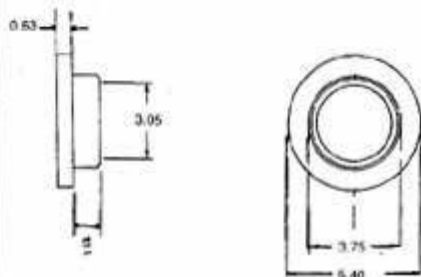

31-40-14 GF

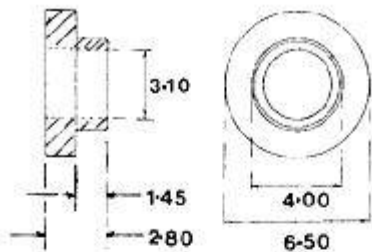

31-35-25 GF

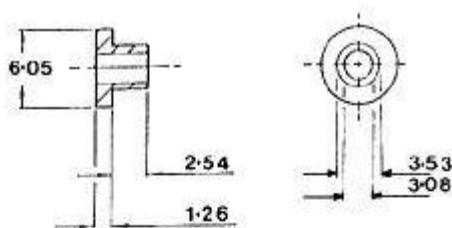

3-38-05 GF.PPS

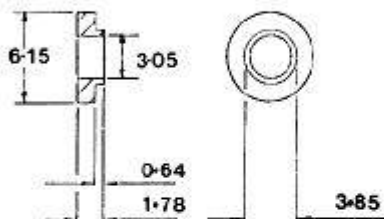

3-38-13 GF

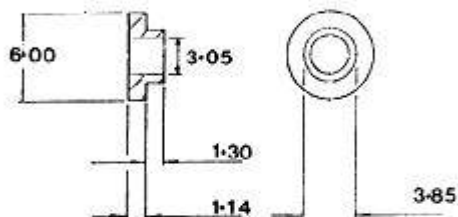

3-38-32 GF.PPS

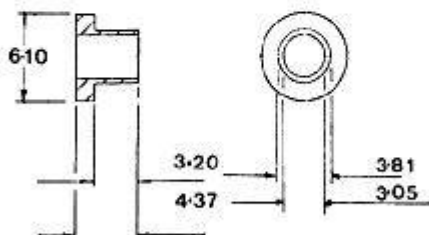

3-38-39 GF.PPS

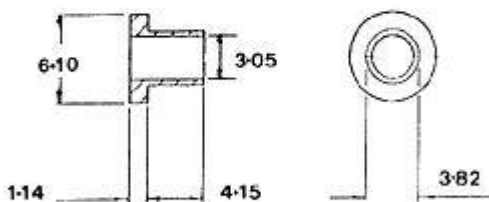

3-38-51 GF.PPS

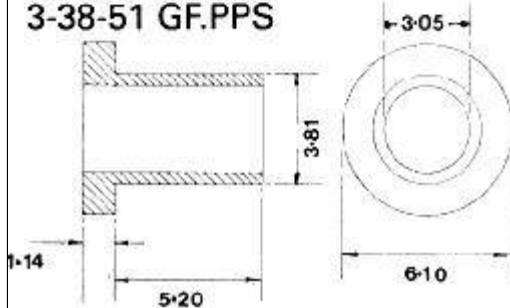

3-38-80 GF

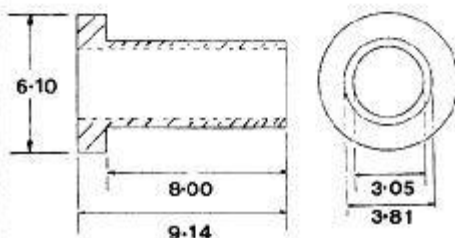

36-48-24 GF

No Longer Available - ask for alternatives

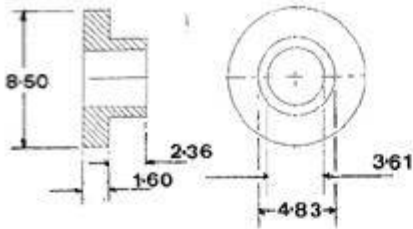

4-63-1 N

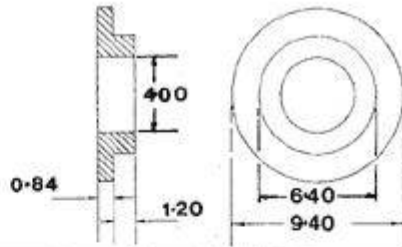

4-63-15 N

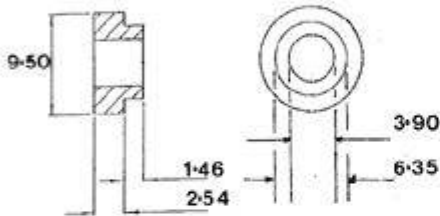

44-56-07 GF

No Longer Available - ask for alternatives

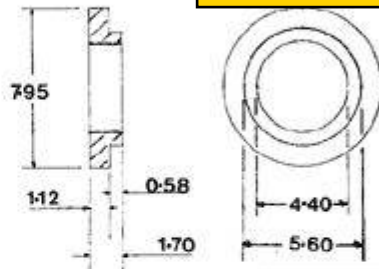

47-64-23 N.PPS

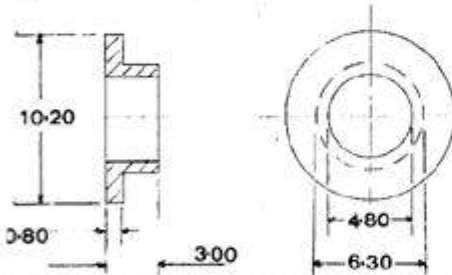

64-79-22 N.PPS

Nylon no longer available

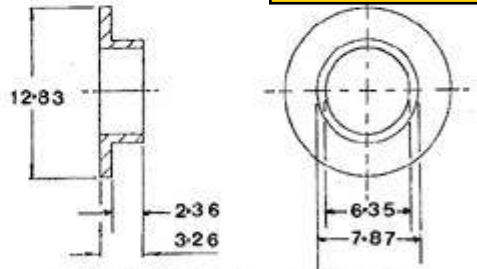

65-118-12 GF

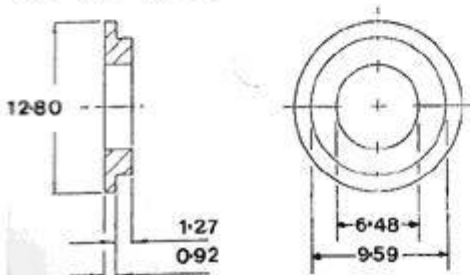

31-35-15 GF

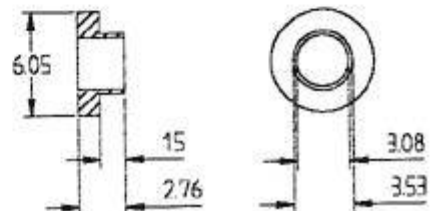

MEC27AN

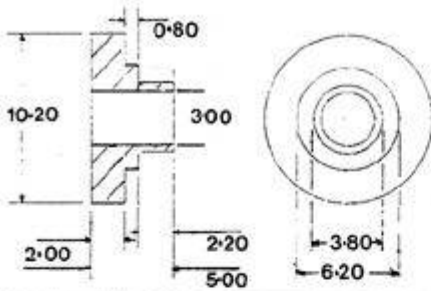

M2730 (N)

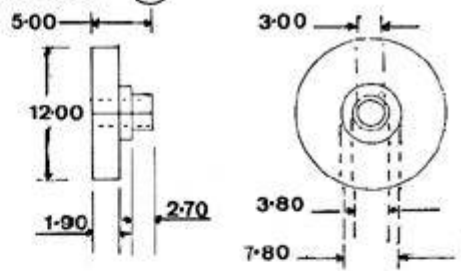

41-55-30 GF

Π [Ἀ] * ^ |
Ο ς α β γ δ ε ζ η θ ι κ λ μ ν ξ ο π ρ σ τ υ φ χ ψ ω

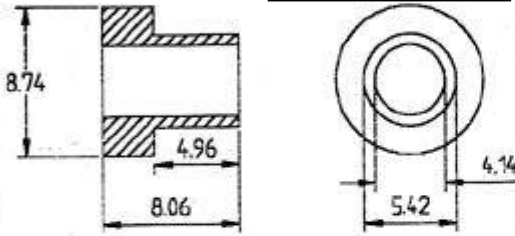

31-48-51

Π [Ἀ] * ^ |
Ο ς α β γ δ ε ζ η θ ι κ λ μ ν ξ ο π ρ σ τ υ φ χ ψ ω

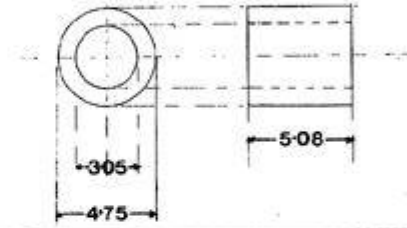

31-48-57

Π [Ἀ] * ^ |
Ο ς α β γ δ ε ζ η θ ι κ λ μ ν ξ ο π ρ σ τ υ φ χ ψ ω

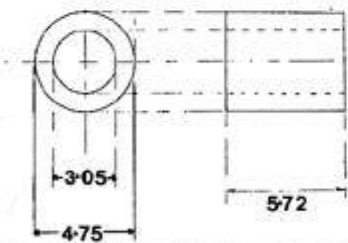

31-48-64

Π [Ἀ] * ^ |
Ο ς α β γ δ ε ζ η θ ι κ λ μ ν ξ ο π ρ σ τ υ φ χ ψ ω

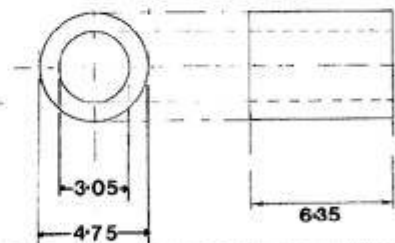

M267028 (N)

Π [Ἀ] * ^ |
Ο ς α β γ δ ε ζ η θ ι κ λ μ ν ξ ο π ρ σ τ υ φ χ ψ ω

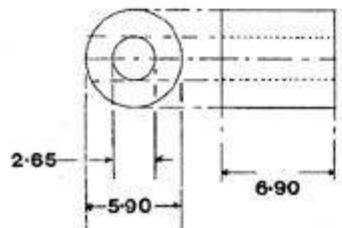

LED 60/70 (N)

Π [Ἀ] * ^ |
Ο ς α β γ δ ε ζ η θ ι κ λ μ ν ξ ο π ρ σ τ υ φ χ ψ ω

