

Specifications switches: Specifications Sealing Boot:

- through-hole or SMD
- 50mA/24VDC
- single pole/momentary
- 10.000.000 operations life time
- IP67 sealing
- temperature range:
low temp: -40/+115°C
high temp: -40/+160°C

- Operating temperature: -40/+85°C
- IP67 sealing
- sealing life time: 2.000.000 operations
- material: silicone

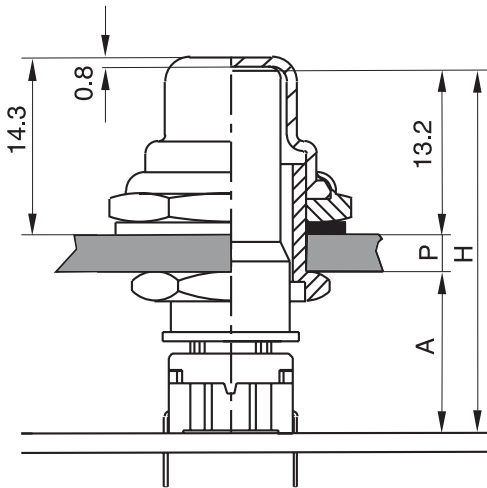

$$H = A + P + 13.2$$



This leaves nominal 0.3 mm clearance between the top of the cap and the inner side of the sealing boot to accomplish assembly tolerances. **A** can be chosen between 10 -13 mm, we recommend 10 mm to reduce building height and optimize cap guidance.



A	P	CAP	H	BUSHING
10.0	1.0	AQCXX-24.2	24.2	AQN-0.5
10.0	2.0	AQCXX-25.2	25.2	AQN-0.5
10.0	3.0	AQCXX-26.2	26.2	AQN-2.5
10.0	4.0	AQCXX-27.2	27.2	AQN-2.5

Cap is available in black (09) or transparent (11).

The dimension H is the overall height of the switch+cap.
Bushing AQN-0.5 accepts panel thickness (P) 0.5-2.5 mm.
Bushing AQN-2.5 accepts panel thickness (P) 2.5-4.0 mm.
Panel cut out \varnothing 12.0 \pm 0.2.

How to order

3 F	<input type="checkbox"/>	<input type="checkbox"/>	+	AQN	<input type="checkbox"/> · <input type="checkbox"/>	+	AQC	<input type="checkbox"/>	-	<input type="checkbox"/> · <input type="checkbox"/>	+	AQB01	<input type="checkbox"/>
Switch	Mounting	L 6 low temp. H 9 high temp.		Bushing	Panel		Cap			Overall Height		Sealing boot, incl. sealing ring	
4 F	T through-hole S surface mount				0.5 2.5		09 black 11 transparent			24.2 25.2 26.2 27.2		09 black 11 transparent	

3 F	T	<input type="checkbox"/>	+	<input type="checkbox"/>	<input type="checkbox"/>	+	AQN	<input type="checkbox"/> · <input type="checkbox"/>	+	AQC	<input type="checkbox"/>	-	<input type="checkbox"/> · <input type="checkbox"/>	+	AQB01	<input type="checkbox"/>
Switch	Mounting	L 6 low temp. H 9 high temp.		LED	Bushing	Panel	Cap			Overall Height		Sealing boot, incl. sealing ring				
4 F	T through-hole			00 blue 20 green 40 yellow 60 white 80 red 2040 green/yellow 8020 red/green 8040 red/yellow		0.5 2.5	11 transparent			24.2 25.2 26.2 27.2		11 transparent				

Keycaps shown on this page can also be used on **illumec™ switch 4F**

Ordering example: AQB0109 + AQC09-27.2 + AQN-2.5 + 3FTL6